



Simplicity Bubblers
Chilled Beverage Dispensers 2x9 L+1x18 L, agitator model with locking lid and UK plug

ITEM # _____

MODEL # _____

NAME # _____

SIS # _____

AIA # _____



CCCRKY (ECS3D22UK) * NOT TRANSLATED *

Main Features

- Agitation function for fresh juices, coffees, or teas with minimal foaming system.
- Easy-off bowl release system for faster and easier assembly and disassembly.
- User friendly design enables machine to dispense product till the very last drop.
- Dispense 3 flavors in (2) 9 L and (1) 18 L easy-clean bowls with 23 cm cup clearance.

Construction

- Pre-mix dispenser with stainless steel base and clear plastic bowls.
- Fewer removable parts to simplify cleaning and reduce maintenance.
- Temperature range from 1.7 - 5° C.
- Compact size of 52 cm wide saves valuable counter space.
- The air intakes from the bottom and exhaust to back.
- Locking lid for added safety against tampering.
- Refrigerant type: R290.

APPROVAL: _____



Front

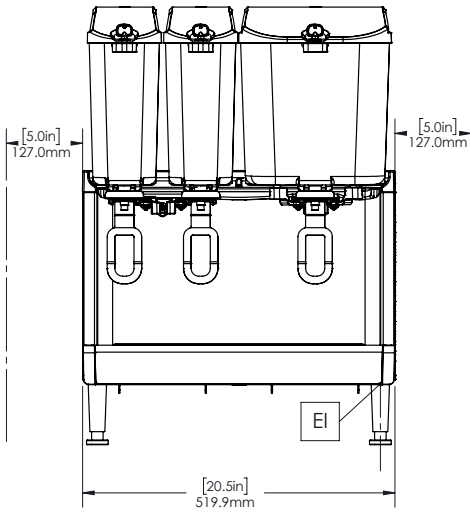

Side

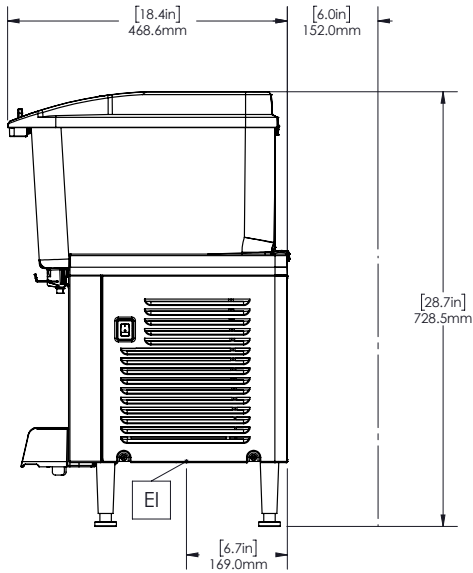

Top

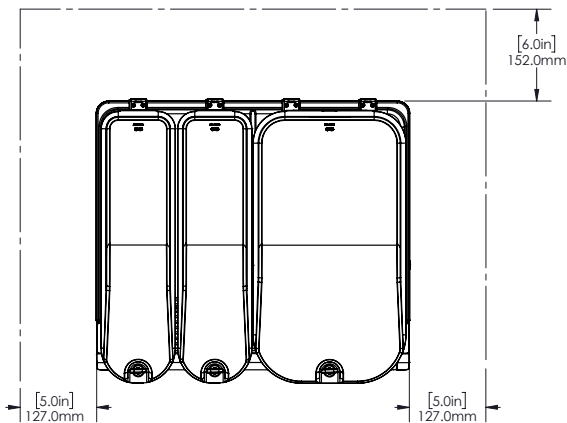



Electrolux
PROFESSIONAL

Simplicity Bubblers
Chilled Beverage Dispensers 2x9 L+1x18 L,
agitator model with locking lid and UK plug

Electric

Supply voltage: 220-240 V/1N ph/50/60 Hz
Electrical power max.: 0.6 kW

Key Information:

Net weight: 32 kg
Shipping weight: 24 kg
Shipping height: 530 mm
Shipping width: 380 mm
Shipping depth: 480 mm

Sustainability

Refrigerant type: R290
Refrigerant weight: 85 g



Simplicity Bubblers
Chilled Beverage Dispensers 2x9 L+1x18 L, agitator model with locking lid and UK plug
The company reserves the right to make modifications to the products without prior notice. All information correct at time of printing.

2026.04.15